

# HANDLEIDING



Container ombouw Peter



# BENODIGDHEDEN

## Benodigde gereedschappen

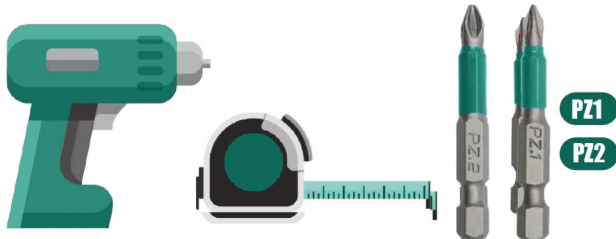

## Plank 135 x 16 mm

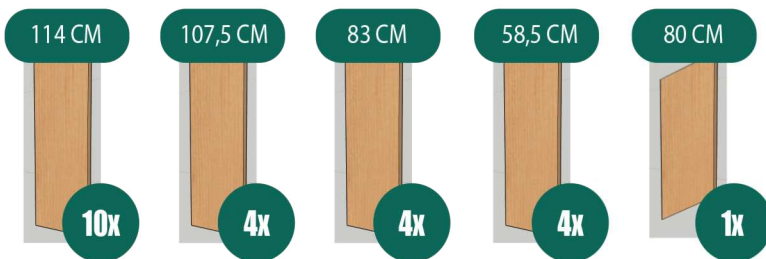

## Balk 67 x 44 mm



## Balk 44 x 44 mm

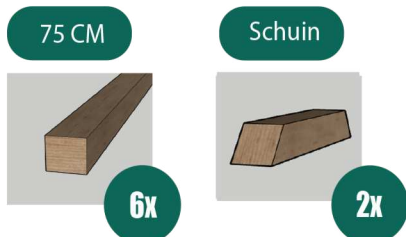

## Instructies

Controleer alle onderdelen op deze onderdelen lijst vóór montage. Start niet met monteren bij ontbrekende onderdelen.

Neem de instructies van montage aandachtig door en volg deze stap voor stap voor een goede montage.

Voor optimale bescherming van de materialen adviseren wij het product op een vlakke en verharde ondergrond te plaatsen.

## Losse onderdelen

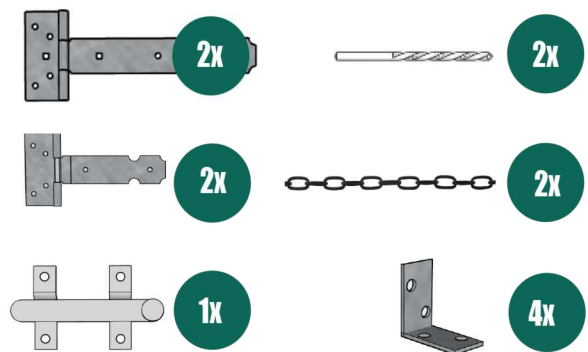

## Schroeven & pluggen



**!** Let op: Alles voorbereiden

# MONTAGE STAPPENPLAN

## Montage stap 1

- 2x Balk 67x44mm van 119 cm
- 1x Balk 44x44mm van 75 cm
- 4x Schroef 80 mm

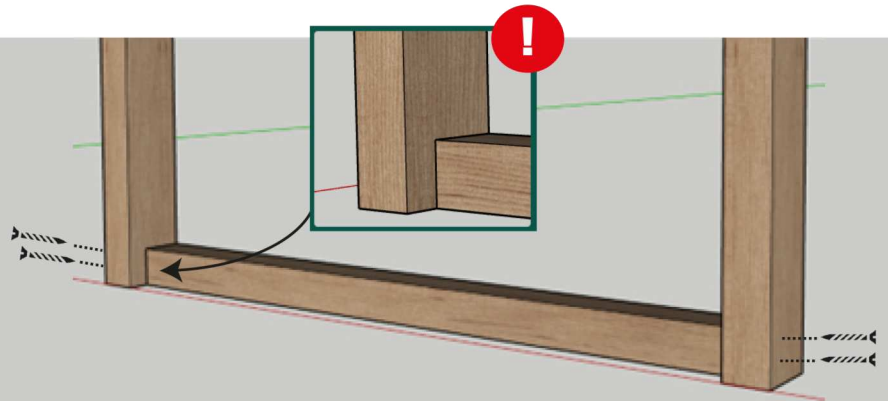

## Montage stap 2

- 1x Balk 67x44mm van 75cm
- 4x Schroef 80mm

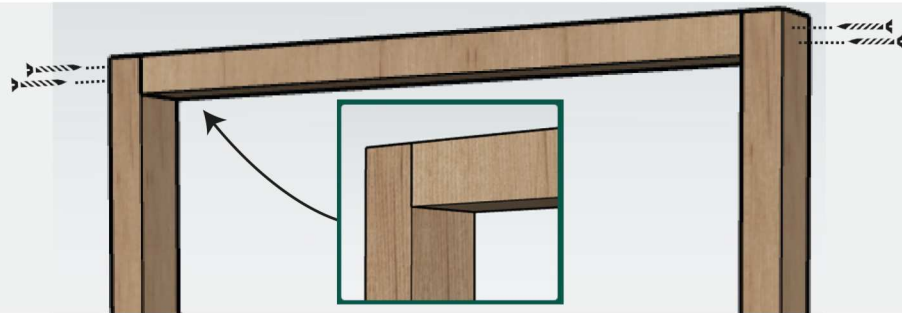

## Montage stap 3

- 1x Balk 44x44mm van 75cm
- 3x Schroef 80mm

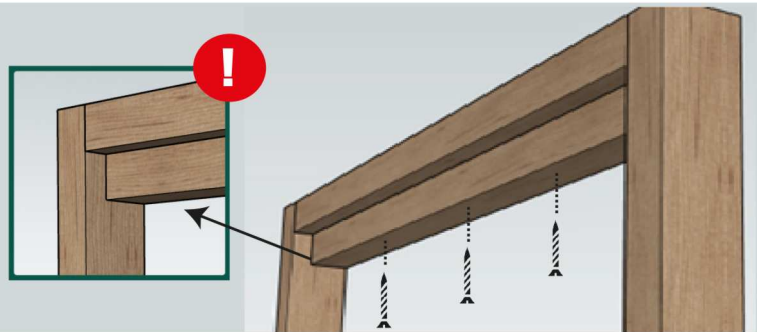

## Montage stap 4

- 1x Balk 44x44mm van 75cm
- 4x Schroef 80mm

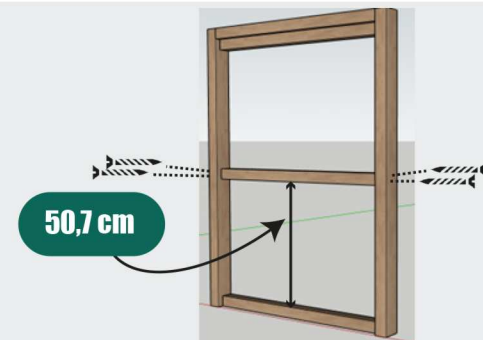

## Montage stap 5

- 5x Plank 135x16mm van 114cm
- 30x Schroef 30mm

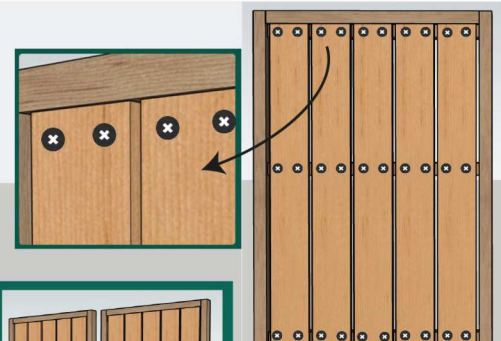

## Montage stap 6

Herhaal stap 1 t/m 5 om tot 2 identieke panelen te komen.



# MONTAGE STAPPENPLAN

## Montage stap 7

- 1x Balk 67x44mm van 59,5 cm
- 4x Schroef 120mm

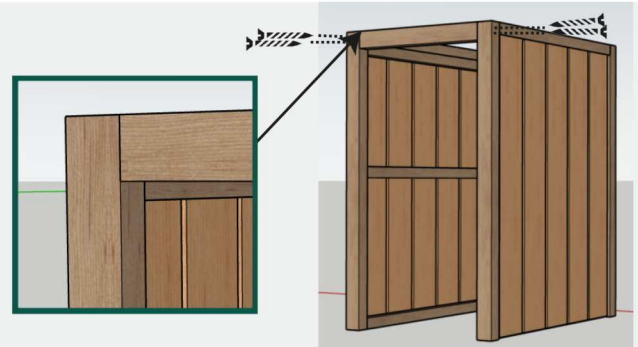

## Montage stap 8

- 1x Balk 67x44mm van 59,5 cm
- 4x Schroef 120mm

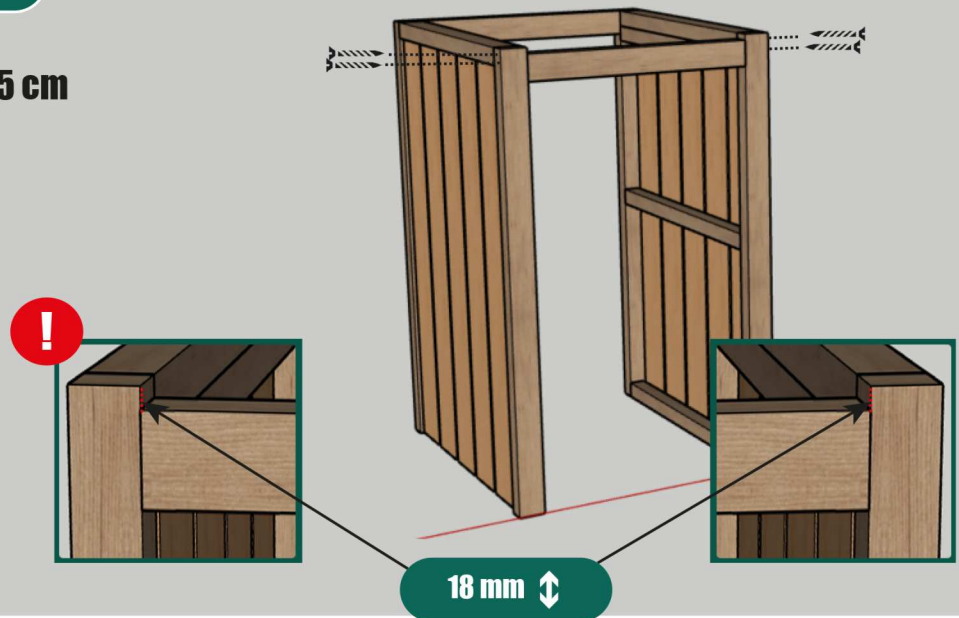

## Montage stap 9

- 4x Stoeelhoek
- 8x Slagplug 40mm
- 8x Schroef 30mm

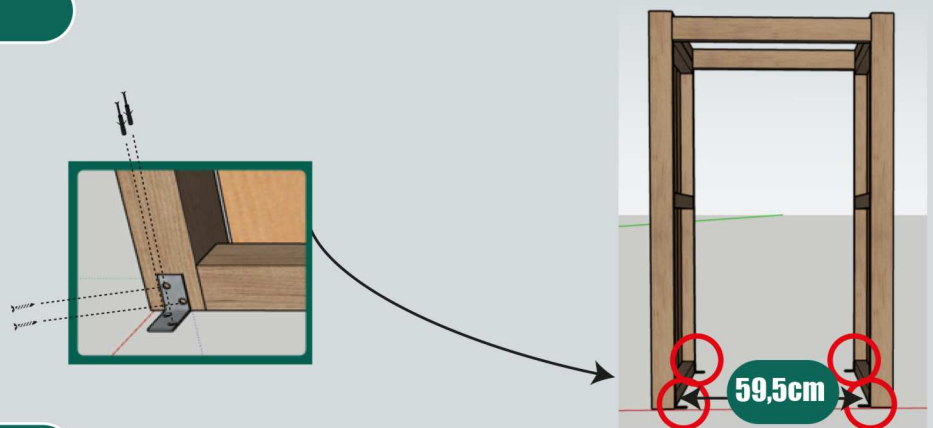

## Montage stap 10

- 4x Plank 135x16mm van 83cm
- 2x Plank 135x16mm van 58,5cm
- 32x Schroef 30mm

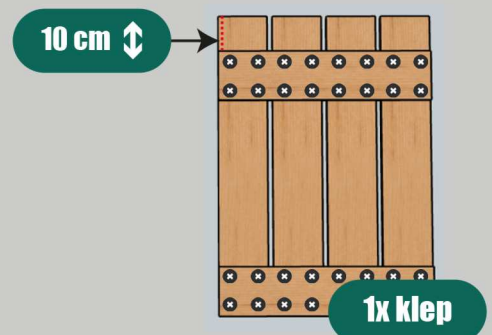

# MONTAGE STAPPENPLAN

## Montage stap 11

- 4x Plank 135x16mm van 107,5cm
- 2x Plank 135x16mm van 58,5cm
- 1x Plank 135x16mm van 80cm (schuin)
- 46x Schroef 30mm

10 cm 

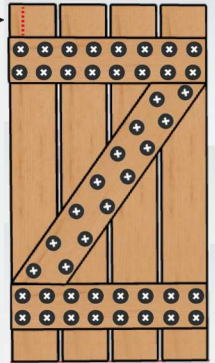

1x deur

## Montage stap 12

- 1x Klep
- 2x Scharnier geheng kort
- 12x Schroef 30mm

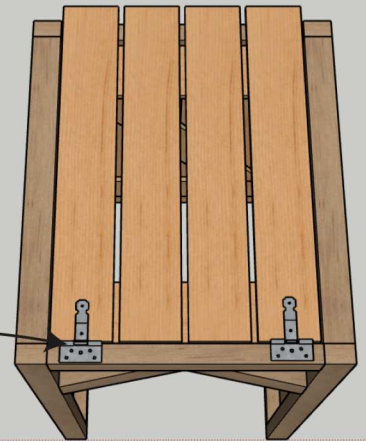
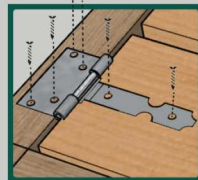

## Montage stap 13

- 1x Deur
- 2x Scharnier geheng lang
- 1x Slot
- 18x Schroef 30mm

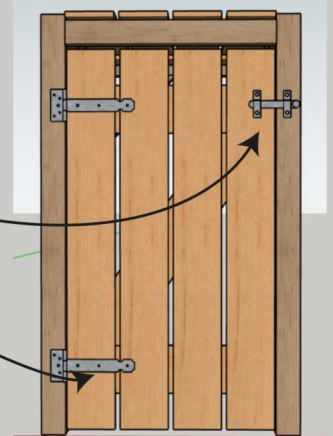
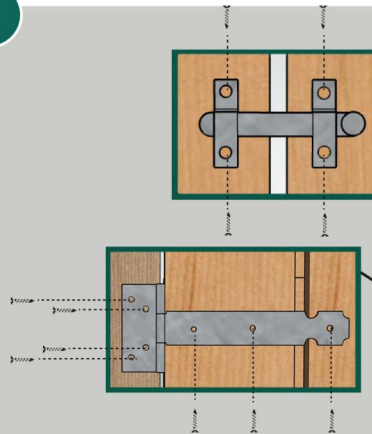

## Montage stap 14

- 2x Balk 44x44mm (schuin gezaagd)
- 4x Schroef 80 mm

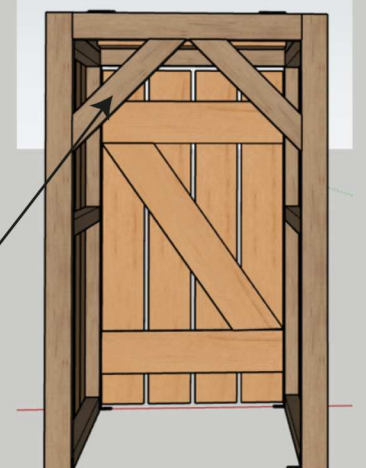

# MONTAGE STAPPENPLAN

## Montage stap 15

- 1x Ketting
- 1x Schroef 30mm

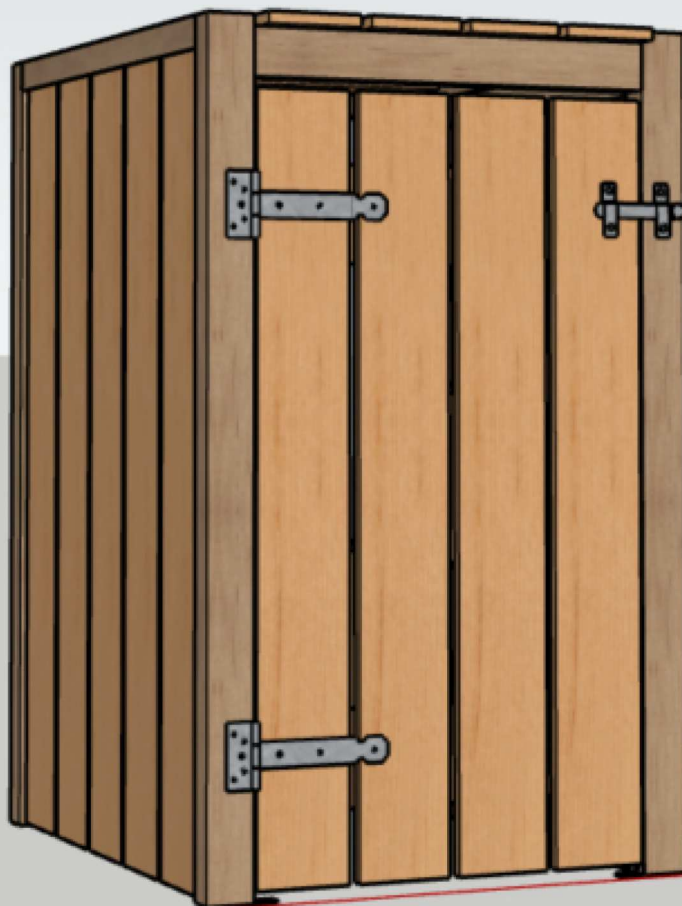
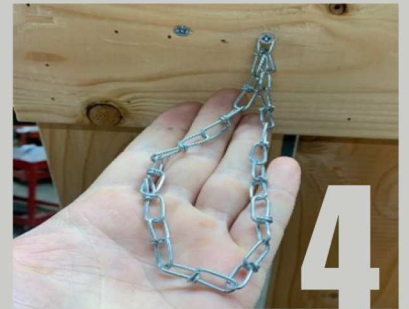

# ACHTERWAND MONTAGE STAPPENPLAN

## Plank 135 x 16 mm

118 CM



4x

## Balk 44 x 44 mm

59,5 CM

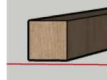

1x

## Schroeven & pluggen

16x



Schroef 30 mm

4x



Schroef 100 mm

### Montage stap 1

- 1x Balk 44x44mm van 59,5 cm
- 4x Schroef 100 mm



### Montage stap 2

- 1x Plank 135x16mm van 118 cm
- 4x Schroef 30mm

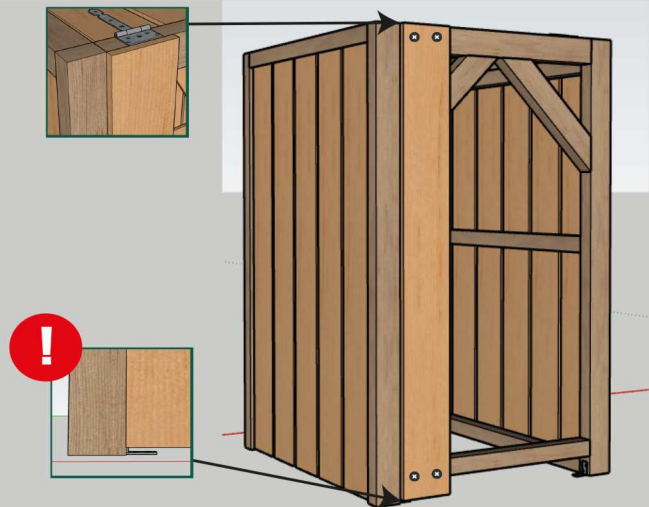

### Montage stap 3

- 3x Plank 135x16mm van 118 cm
- 12x Schroef 30mm

**!** Verdeel de planken over de volledige breedte

